



AMERICAN HOLTZKRAFT, INC.

Corporate Sales Office & Manufacturing
9242 Route 35
Mt. Pleasant Mills, Pennsylvania 17853

570 / 539-8945
570 / 539-2592 fax

Orlando Regional Sales Office
400 Countyline Court
Unit 5
Oakland, Florida 34787

407 / 656-8612
407 / 654-0624 fax

www.holtzkraft.com
customerservice@holtzkraft.com

 Visit our [pinterest page](https://www.pinterest.com/amholtzkraft) today to view
our extensive installations!
www.pinterest.com/amholtzkraft

 Like our Facebook page

Printed in the USA / 2500 / 02-2016

MARKET UMBRELLAS & Outdoor Furnishings



AMERICAN HOLTZKRAFT, INC.

MARKET UMBRELLAS
& Outdoor Furnishings

TABLE OF CONTENTS

3 MARKET UMBRELLA ANATOMY

5 WOOD UMBRELLAS -
KEYSTONE COLLECTION

7 WOOD UMBRELLAS -
SYNTHETIC THATCH COLLECTION

9 ALUMINUM UMBRELLAS

11 AUTO-OPENING INCREDIBLE
ALL ALUMINUM UMBRELLAS

13 ALUMINUM UMBRELLAS
THEME PARK - PAGODA

15 DAYBEDS / CABANAS

17 TENT CABANAS

19 CANTILEVER COLLECTION

21 CUSTOM LOGO OPTIONS

23 UMBRELLA STANCHIONS

25 UMBRELLA STANDS & BASES

27 UMBRELLA LIGHTING

28 AMERICAN HOLTZKRAFT GALLERY

29 AMERIKRAFT™
SYNTHETIC WOOD FURNITURE

31 RECYCLED PLASTIC FURNITURE

33 PRODUCT INDEX



AMERICAN HOLTZKRAFT, INC.

WELCOME TO
AMERICAN HOLTZKRAFT...

...the best kept secret in central Pennsylvania.
In the quiet, rural community of Mt. Pleasant Mills,
our family and talented staff have been manufacturing
market umbrellas and outdoor furnishings for over 30 years.

At American Holtzkraft, we have merged imagination
and high quality materials with renowned Pennsylvania
quality craftsmanship to produce the finest quality market
umbrellas in the industry. Built to last, our umbrellas are
constructed with Northern Ash, the hardest wood grown
in the United States. And, with canopies of attractive,
durable fabrics, multi-laminated hubs and finials, and
solid brass hardware - these umbrellas exude quality.

Beauty, workmanship, and functionality make our
umbrellas and outdoor furnishings a graceful addition
to any patio, terrace, or beach setting.

Our commitment to detail, workmanship and our
continued exploration of innovative designs are the
foundation of American Holtzkraft. Satisfying our
discerning customers, who appreciate Pennsylvania
quality craftsmanship for today's lifestyle, is our goal.



See for yourself...
the beauty...
the detail...
the workmanship.

When you select an
American Holtzkraft product,
you know you've made a special choice!

**Pennsylvania quality craftsmanship
enduring & lasting beauty**

AMERICAN HOLTZKRAFT'S MARKET UMBRELLA ANATOMY



- 1 ROTATING CANOPY FINIAL**
Wood multi-laminated, carved, and hand tooled to a simple, elegant accenting finial.

Aluminum, solid machined aluminum finial made to last a lifetime. Other non-standard finial styles are available.
- 2 REINFORCED LEADING EDGE**
Fabric is double folded and triple stitched with ultraviolet (UV) protected thread for matching longevity of fabric and thread.
- 3 AIR VENTS**
Single and double vent options allow strong wind to escape from canopy; providing a safe and efficient means of dissipating air from the umbrella.
- 4 REINFORCED STRESS POINTS**
A double layer of fabric is sewn in and double stitched to provide added strength against the stresses of wind and weather.
- 5 TOP & BOTTOM HUBS**
Wood; all hubs are wood multi-laminated & reinforced with stainless steel screws for optimal strength.

Aluminum; solid machined aluminum hubs with optional powder coat finish.

Tested stainless steel fasteners are used for operating strength against harsh environments.
- 6 PIN & CHAIN**
Solid brass or stainless steel pin and chain are used to adjust the height and tautness of canopy fabric. Heavy chain keeps pin intact with umbrella.

- 7 POLE (ALUMINUM) OR POLE (WOODEN)**
American Holtzkraft, Inc. boasts “the original steel pipe reinforced laminated pole”, which provides tested strength over the thin steel rods used by some manufacturers. North American Hardwood Ash (used for baseball bats) is dried and cut lengthwise and horizontally laminated with marine grade glue tested for outdoor use.

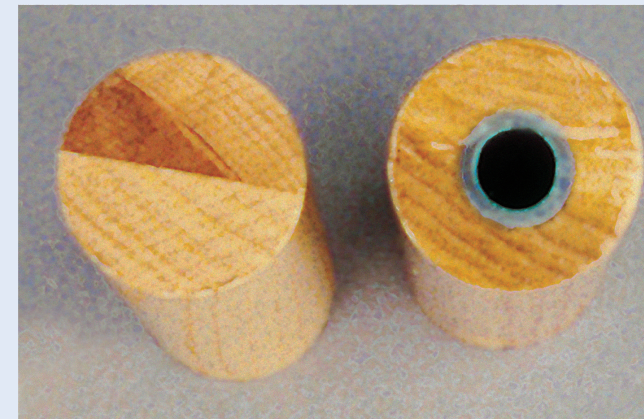

Wood standard pole sizes 1-1/2", 2" and 2-3/8".

Aluminum poles are made of heavy marine grade 6061-T6 seamless aluminum 1/8" wall thickness.

Optional finishes include powder coated finish on aluminum umbrellas.

FOUR LIFT MECHANISMS:

- Traditional manual lift
- Single pulley
- Double pulley
- Automatic opening device

AMERICAN HOLTZKRAFT'S HARDWOOD FINISHES

Distinctive hardwood grains are preserved by slow kiln-drying, sealing, and a slow drying of multiple natural or wood toning finishes, in the colored finishes below:

- A** Teak
- B** Natural
- C** Mahogany
- D** Stonehenge Gray
- E** White Wash
- F** Black Enamel
- G** White Enamel

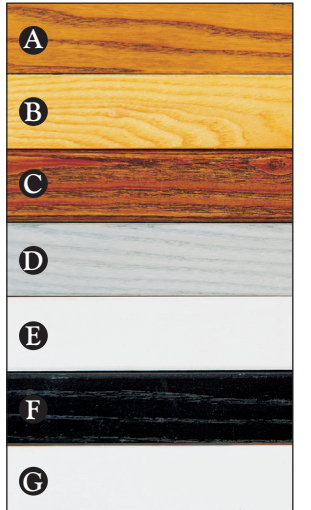

Color reproduction of the above finish colors, is as close as possible using commercial printing methods.

STANDARD FEATURES

Durable Varnish

- Multiple coats of marine varnish increase weather and water resistance
- Varnish is specially formulated with ingredients that screen out the destructive ultraviolet rays of the sun, which is one of the principle causes of deterioration and loss of gloss on any varnish film, and helps prevent the wood from aging dark
- VOC compliance meets clean air standards
- Clear air formula

Wood Stains

- Penetrates and seals the wood from moisture while adding rich color
- Semitransparent feature shows wood grain and adds long-lasting protection

All umbrellas and furniture products are available in a variety of wood species including: Plantation-Grown Teak and Western Cedar.

American Holtzkraft, Inc. reserves the right to change product specifications without notice.

WOOD UMBRELLAS - KEYSTONE COLLECTION

The cornerstone of our company - simple, elegant umbrellas with patented features, making this series the best known in the industry.



Model #702



Model #705



Model #707



Model #711.5



Model #718

OCTAGON UMBRELLAS

MODEL #701 6' OCTAGON UMBRELLA
(1-1/2" Pole)

MODEL #702 8' OCTAGON UMBRELLA
(1-1/2" Pole)
(1-1/2" Steel Reinforced Pole)

MODEL #703.5 10' OCTAGON UMBRELLA
(1-1/2" Steel Reinforced or 2" Pole)

MODEL #705 12.5' OCTAGON UMBRELLA
(2" Steel Reinforced or 2-3/8" Pole)

MODEL #706 15' OCTAGON UMBRELLA
(2" Steel Reinforced or 2-3/8" Pole)

MODEL #722 15' DECAGON UMBRELLA
(2-3/8" Steel Reinforced Pole)

SQUARE UMBRELLAS

MODEL #707 5' SQUARE UMBRELLA
(1-1/2" Pole)

MODEL #709 7' SQUARE UMBRELLA
with 8 Ribs (1-1/2" or 2" Pole)

MODEL #710 8' SQUARE UMBRELLA
with 8 Ribs (1-1/2" Steel Reinforced
or 2" Pole)

MODEL #711.5 10' SQUARE UMBRELLA
with 8 Ribs (1-1/2" Steel Reinforced
or 2" Pole)

RECTANGULAR UMBRELLAS

MODEL #716 6' x 8'
RECTANGULAR UMBRELLA
(1-1/2" Steel Reinforced Pole)

MODEL #718 8' x 10'
RECTANGULAR UMBRELLA
(2" Steel Reinforced Pole)



Note

ROTATING CANOPY & DOUBLE VENT OPTIONS

Our original design rotates around the axis of our steel reinforced pole dissipating stress & excess wind through the canopy rotation. This ingenious way of addressing the hours of stress applied to the mechanisms of the market umbrella is protected by our Patent #5020557 & proven with actual performance stress testing.

Paired with our double vent, which allows the air to escape the canopy in strong winds, makes the umbrella more durable.

WOOD UMBRELLAS- SYNTHETIC THATCH COLLECTION

Features an innovative, natural looking thatch canopy made from injection molded resin and precisely attached to the umbrella canopy.

MODEL #ST702
8' SYNTHETIC
THATCH UMBRELLA
(2" Steel Reinforced Pole)

NATURAL LOOKING STYLE

- Canopy is easily taken off or placed onto an existing umbrella
- Designed for water and air drainage, for long life of thatched canopy
- Attractive both open or closed
- Decagon hub with oversized "truss-like" ribs
- Double rigged double pulley system

OPTIONAL FEATURES

- Option K with standard LED lights imbedded in the ribs
- Fire retardant thatch
- Frames are available sand-blasted and toned for a natural look
- Warranty Options Available on thatch material



American Holtzkraft
Thatch Umbrellas
blend beautifully with
natural landscapes.

Our Thatch Umbrellas are fully functional
and attractive both open or closed.

Thatch Umbrella frames are available
sand-blasted and toned for
authentic natural looking style.



ALUMINUM UMBRELLAS

Built to last, these aluminum umbrellas bring strength and durability to the marketplace.



Model #201B



Model #202P



Model #203SRP

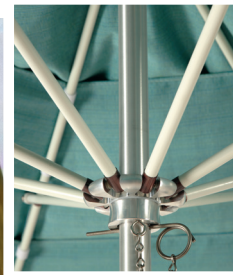
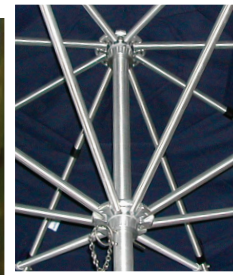
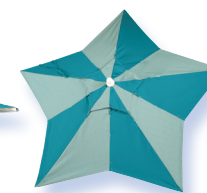

ALUMINUM UMBRELLAS

MODEL #201B 6.5' ALUMINUM ROTATING CANOPY UMBRELLA (with aluminum ribs & 1-1/2" Pole)

MODEL #201P 6.5' ALUMINUM ROTATING CANOPY UMBRELLA (with pultrusion ribs & 1-1/2" Pole)

MODEL #202B 8.5' ALUMINUM ROTATING CANOPY UMBRELLA (with aluminum ribs & 1-1/2" Pole)

MODEL #202P 8.5' ALUMINUM ROTATING CANOPY UMBRELLA (with pultrusion ribs & 1-1/2" Pole)

MODEL #203SRP 9' STAR UMBRELLA (with pultrusion ribs & 1-1/2" Pole)

Our New & Improved hub is solid aluminum, machined down to a sleek modern design. Each rib is fastened to the hub via stainless steel pins, which are secured by large screws, permitting easy repairs in the field. This durable umbrella and our patented rotating canopy, will permit you to experience the most dependable umbrella in the industry for all weather conditions.

STANDARD ALUMINUM UMBRELLA FEATURES

- New & Improved solid aluminum finial
- Marine grade aluminum pole tempered to provide lasting strength & durability
- Rotating canopy (Patent No. 5020557) releases stress from the pole and hubs
- Brushed aluminum finish
- Stainless steel hardware and neoprene spacers protect all moving parts from corrosion and allow for easy operation
- Double stitched reinforced pockets
- Reinforced pockets secure the canopy the canopy to the ribs of the frame, guaranteed not to fail

OPTIONAL FEATURES

- Double vent - allows air to escape from canopy
- Unbreakable pultrusion ribs
- Powder coat finish



Note

ABOUT OUR UMBRELLAS & WIND TUNNEL TESTING

American Holtzkraft, Inc. takes this opportunity to boast the results of its official wind tunnel test performed by a respected university, achieving an impressive 74.5mph before any failure. Complete test results for most models are available upon request, with a video of various tests for your viewing pleasure.

AUTO-OPENING
INCREDIBLE
 ALUMINUM
 UMBRELLAS

Our new contemporary designed Incredible Aluminum Umbrella, offers the same great incredible umbrella features and more!



Eco friendly brushed aluminum has hand polished finish saving the environment from any coating process by using high grade marine aluminum.



Held in place (both open and closed) by a newly designed compression system.

Our Incredible Aluminum Umbrellas are available in either the 8' Hexagon Umbrella (large image) or the 7' Square Umbrella (inset image)

Model #220

Model #218P



MODEL #218P 8' HEXAGON INCREDIBLE ALUMINUM UMBRELLA (Pultrusion Ribs & 1-1/2" Pole)*

MODEL #220 7' SQUARE INCREDIBLE ALUMINUM UMBRELLA (Aluminum Ribs & 1-1/2" Pole)*

*Available in either unbreakable pultrusion or aluminum ribs.

NEWLY DESIGNED UMBRELLA

Our New Incredible Aluminum Umbrella uses a unique inner / outer pole system coupled with an innovative compression devise to lift the ribs, up and out of the way for clearance of the table.

EXCEPTIONAL FEATURES

- Machined aluminum hub with removable U-brackets
- UHMW plastic insert inside the hub prevents scratching on the pole
- Compression knob eliminates pin & chain
- Reinforced pockets secure the canopy to the ribs of the frame, guaranteed not to fail.
- Must be secured by ties when in the closed position
- 80" head clearance (113" overall height in closed position)
- Available in single vent only
- Standard auto opening feature



Note

THESE UMBRELLAS ARE GREAT FOR OTHER APPLICATIONS

American Holtzkraft's Auto-opening Incredible Aluminum Umbrellas are great for Kiosks, Point-of-Sale Stations, and Food/Merchandise Carts.

THEME PARK COLLECTION - PAGODAS

Festive is the atmosphere this uniquely designed pagoda umbrella will create for your guests.



MODEL #205 8.5' PAGODA
UMBRELLA
(1-1/2" Pole)

If you are tired of the old-fashioned traditional wire frame aluminum umbrellas, bending out of shape with dangerous metal ends protruding from the fabric - then this pagoda style umbrella is your replacement. Superb quality and engineering are standard on this exceptional addition to our fine line of market umbrellas.

UNIQUE FEATURES

- Pagoda style spring-loaded finial maintains tautness of the fabric in the open position
- Rib framework of 3/4" tubular aluminum and heavy 1/16" wall thickness
- Reinforced pockets secure the canopy to the ribs of the frame, guaranteed not to fail
- Available in polished aluminum or in any RAL powder coat finish at an upcharge



DAYBEDS / CABANAS

*International & worldwide traditions,
providing elegant lasting styles.*

MODEL #760 4' x 8' BEACH CABANA



Marine-grade aluminum frame is totally collapsible and features boat and awning weight fabric choice. This original design has been refined to perfection and functions flawlessly while protecting even the most discriminating guest.



This Beach Cabana features an inclusive side pocket at no extra charge - the perfect convenient place to store a magazine, sunscreen or your favorite sunglasses, out of the way - within reach.

- Our Cabana can be color-coordinated to match any of our market umbrellas
- Premium Cushions with Quick-dry foam
- Durable Marine Grade Sunbrella fabric
- Wind vents in back of cabana
- Our beach cabana can also be attached to one of our daybeds or double-chaise loungers for a more private setting



TENT CABANAS

ALUMINUM FRAME
 MODEL #241 7' x 7' TENT CABANA
 MODEL #244 10' x 10' TENT CABANA

WOOD FRAME
 MODEL #741 7' x 7' TENT CABANA
 MODEL #744 10' x 10' TENT CABANA



Frame construction of our marine-grade aluminum or wood Tent Cabanas, are easy to assemble for the privacy of your guests and parties.

All grades of fabrics are available with two convenient sizes to fit any pool or patio area.

Our wood framed Tent Cabanas, features a quickly-collapsible option (pictured at left) for foul weather.

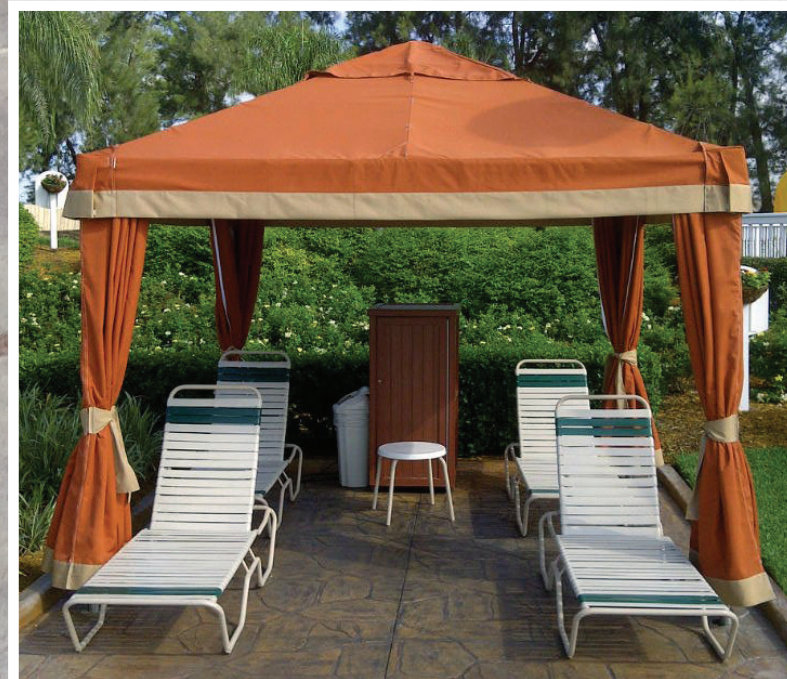

CANTILEVER COLLECTION

This unique design requires no center pole and has a greater clearance height - freeing up precious space.



MODEL #264 10' SQUARE CANTILEVER
UMBRELLA

UNIQUE DESIGN & ENGINEERED FEATURES

- Umbrella can be opened & closed with a hand crank (provided)
- The unit opens and closes with a single, safe crank action
- Powder coated umbrella frame and heavy rib construction throughout this product makes it an ideal umbrella for the unusual coverage area in your commercial installation
- All replacement parts are available to order for in-use serviceability
- Available with Single Vent or Double Vent

BASE OPTIONS (images shown at right)

- A** Offset Base* to hold standard concrete pavers available at most home & garden centers. Pavers can also be shipped via freight from American Holtzkraft, Inc. to any of our customers locations.
- B** In-Ground Stanchion
- C** Deck Mounted Plate*

*Optional rotating mechanism available on Offset Base & Deck Mounted Plate

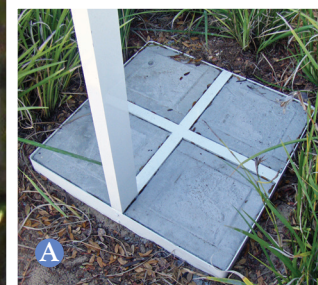

Double Cantilever



CUSTOM LOGO DEVELOPMENT

Many of our umbrella features hold patents for their unique and valuable additions to our products

Logo screen printing is just one of the many custom options offered for your outdoor marketing needs.

Screen printing is possible in as many as 4 different colors, using your own supplied vector formatted artwork of your logo.

LOGO PLACEMENT OPTIONS

- Every canopy panel
- Every other canopy panel
- Every canopy valance
- Every other canopy valance



UMBRELLA STANCHIONS

Our most prestigious umbrella base system can be used in an array of interesting settings.

- PART #606 THREADED STANCHION BASE
- PART #607 THREADED STANCHION SLEEVE
- PART #606T TABLE STANCHION
- PART #607T TABLE STANCHION
- PART #608 CROWD CONTROL STANCHION BASE
- PART #609 CROWD CONTROL STANCHION
- PART #611 STANCHION BASE
- PART #612 QUICK-COUPLING STANCHION SLEEVE
- PART #613 CORE PLUG

Our 304 high-grade stainless steel provides a unique advantage in pool installations.

Our patented stanchion base and stanchion sleeve insert works magnificently with our umbrellas for almost any installation.

DESIGN FEATURES

- Base is set permanently in the ground, a drainage hole is included
- Sleeve provides vertical pole stability
- Two pivot arms automatically lock the sleeve to the base, when umbrella is inserted into the assembly (Model 612)
- Tamper-free sleeve will not separate from the base until the pole is removed (Patented Locking Design No. 5337989)
- Restraint bolt secures the pole to the assembly, preventing the collar from sliding upward exposing the pivot arms
- Sleeve may be removed from the base when not in use, a plug fits into the base when the sleeve is removed
- Stainless steel construction provides superior corrosion resistance

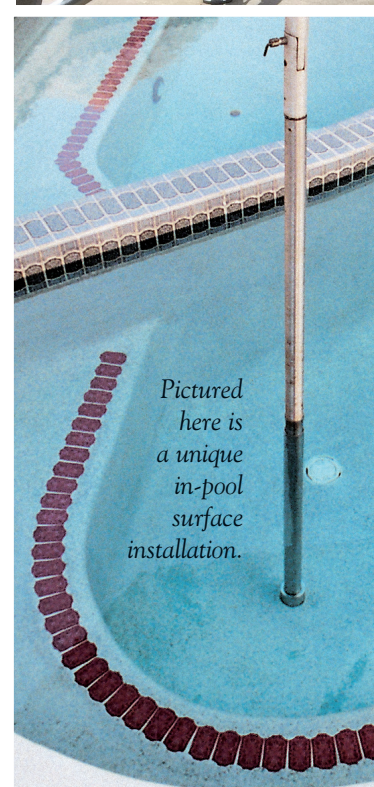

Pictured here is a unique in-pool surface installation.

AMERICAN HOLTZKRAFT DRAWINGS

These drawings are private & proprietary and are supplied on the specific condition that they are not to be used for any purpose or copied or communicated to any person without permission of American Holtzkraft, Inc.

#612 QUICK-COUPLING STANCHION SLEEVE & #611 STANCHION BASE

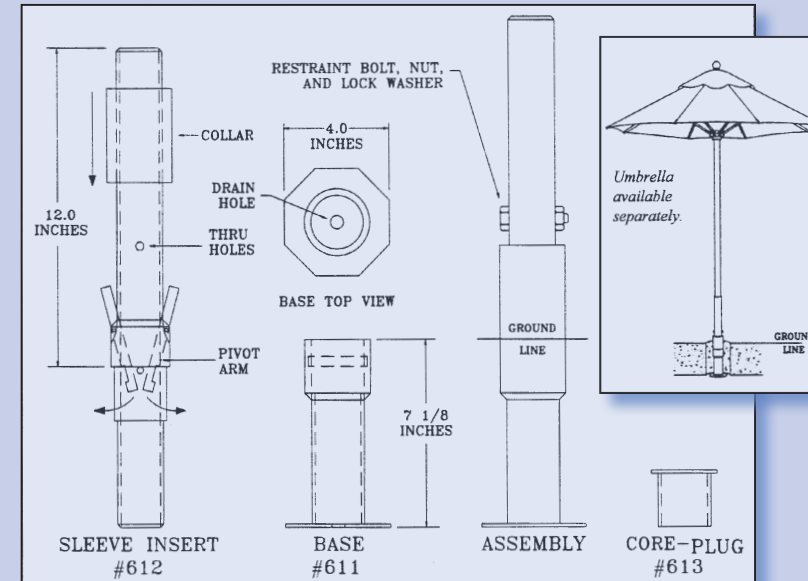

QUICK-COUPLING UMBRELLA STANCHION BASE INSTALLATION

1. Drill 5 inch diameter by 8 inch deep hole through slab and into ground.
2. Tightly pack approximately 1 inch of rock fill into hole until base rests flush and level with the ground surface. It is important to tightly pack filler in order to minimize future settling effects.
3. Pour concrete or equivalent into hole around base.

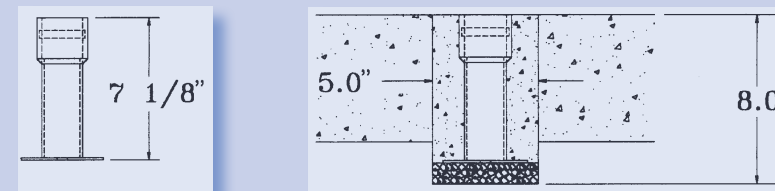

PART #609 CROWD CONTROL STANCHION AND PART #608 STANCHION BASE

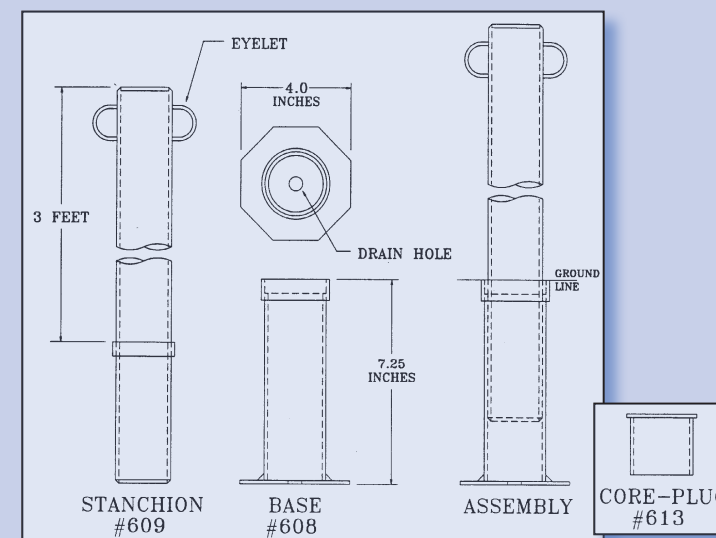

#612 Sleeve Insert

Pictured at left is an example of an unlatched #612 Quick-Coupling Stanchion Sleeve inserted in place in the #611 Stanchion Base, which is installed in a cross section of concrete

When the sleeve is removed, #613 Core Plug is used to seal off the base hole.

Below: Part #613 Core Plug



Available in three sizes
1-1/2", 2", or 2-3/8"

NOTE: Installation must be performed by a qualified contractor and inspected to ensure base is properly secured.

NOTE: Read and follow base installation instructions completely.

UMBRELLA STAND COLLECTION

Our sturdy and durable stands and bases are the ultimate addition for showcasing your umbrellas.

- UMBRELLA STANDS**
- MODEL #602** 57 POUNDS (3/8" Thick)
24-1/2" DIAMETER STEEL
- MODEL #601** 71 POUNDS (1/2" Thick)
21-1/2" SQUARE STEEL
- MODEL #603** 138 POUNDS (1/2" Thick)
30" SQUARE STEEL
- MODEL #604** 70 POUNDS (4" Thick)
20" DIAMETER PLASTIC
CONCRETE FILLED



MODEL #601



MODEL #602

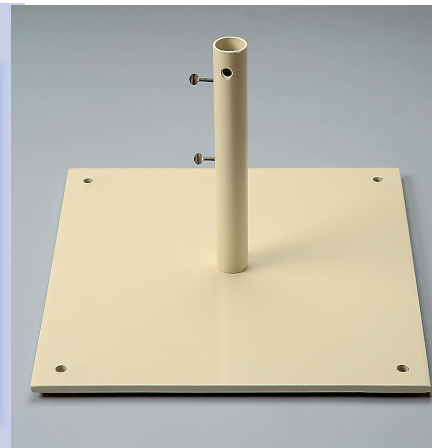
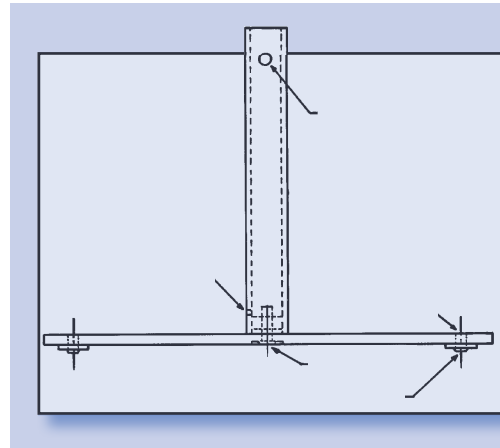

DESIGN FEATURES

- Two-piece construction assembles easily with one carriage bolt
- Thru holes are provided near the top of the sleeve for securing the umbrella to the stand with a restraint pin or bolt (see Note below)
- A drainage hole at the bottom of the sleeve eliminates water buildup
- Four 3/8" diameter holes are provided in the base plate for securing the stand to the surface on which it rests (see Note below)
- Thick, durable feet made of long-lasting tested molded polypropylene provide protection against surface scratches and keeps the base plate off the ground, minimizing moisture buildup

NOTE: Read and follow instructions included with the umbrella stand.

UMBRELLA STAND & BASE OPTIONS

- Four stands to choose from (see above). Ask your representative which umbrella stand is right for your umbrella use
- Three sleeve sizes for 1-1/2" diameter, 2" diameter and 2-3/8" diameter poles, to choose from
- Standard powder coat finishes: black, white, almond (Models 601, 602, and 603 only)
- Additional powder coat finishes available at an up-charge



MODEL #603



MODEL #604

UMBRELLA ALUMINUM BASES

Our stands and bases are engineered to withstand everyday use and weather, for a long-life.



- UMBRELLA BASES**
- MODEL #631** 74 POUNDS
23-1/2" SQUARE
(2-3/4" Thick)

- MODEL #633** 96 POUNDS w/ WHEELS
29-3/4" DIAMETER
(2-3/4" Thick)

- MODEL #635** 126 POUNDS w/ WHEELS
29-3/4" SQUARE
(2-3/4" Thick)

DESIGN FEATURES

- Aluminum shells ship without sand to minimize freight costs. Sand is required for proper base installation
- Thru holes are provided on the sleeve for securing the umbrella to the stand with a restraint pin or bolt (see photo 1)
- Sleeve is welded to a round plate that is secured underneath the base to prevent the sleeve from pulling out of the shell (see photo 2)
- Thick durable feet made of polypropylene provide protection against surface scratches and keeps the base plate off the ground. (see photo 3)
- Wheels are standard on the two larger base sizes
- Standard finishes; black, white, almond or brushed aluminum
- Additional powder coat finishes available at an up-charge

MODEL #631



MODEL #633

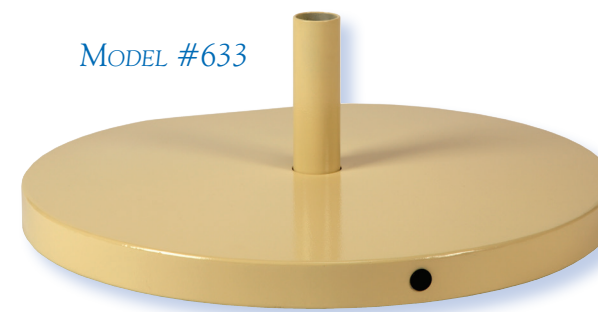

MODEL #635



LED LIGHTING OPTION K

We challenge you to enjoy the most beautiful Tiffany lighting in the world!



OPTION K

UMBRELLA
LED LIGHTING

Our LED Lighting Option K, features 4 volt wiring and neatly concealed LED bulbs, tested for long life and the perfect projection of light, for any moment.

LED lights are available imbedded in each umbrella rib (shown in the upper right photo), or our beautiful down lighting option on the upper hub (shown in the lower right photo).

Our new down lighting option is the first lighting feature offered by American Holtzkraft, Inc. that can be incorporated with our rotating canopy option in areas where wind can be a difficult problem (shown in the lower right photo).

No evening bistro should be without this ambience, supplied by our new and improved all night battery, which clips conveniently to the umbrella pole for safe, low voltage wiring (shown in the two middle photos).



AMERICAN HOLTZKRAFT GALLERY

Enhance your outdoor environment with our beautiful market umbrellas and outdoor furniture.



AMERIKRAFT™ SYNTHETIC WOOD FURNITURE

*The great look of wood,
but with easy care, maintenance
and great environmental advantages.*

Amerikraft™ Furniture is the most realistic synthetic wood available. No other product comes as close to the look and feel of natural wood. We offer a wide variety of standard options and we also provide custom profiles and colors. The only limitation is our collective imagination!

Choose from standard or custom colors, including solid colors and stain-looking finishes to simulate a realistic wood appearance. In addition, we can color match almost any wood appearance, whether natural, stained or painted. And we can texture the surface to provide a more realistic wood effect. We will work with you to give you just the right appearance.

AMERIKRAFT™ ADVANTAGES

- Weather resistant - no rotting, warping, swelling or splintering
- Maintenance free
- Insect resistant
- Water repellent with a Non-slip surface
- UV stable - no color fading
- Thermally efficient
- Can be nailed, screwed and saws like wood
- 100% recyclable, during both production and post-consumer use



MODEL #5406 - 6 FOOT BENCH



MODEL #5800A - WASTE RECEPTACLE W/ ASH TRAY TOP



MODEL #5532 - 32" ROUND TABLE TOP
MODEL #5325DC - STAINLESS STEEL DINING CHAIR W/ SYNTHETIC WOOD SLATS



MODEL #5243 - TOWEL RETURN BIN



MODEL #5417 - 7 FOOT ALUMINUM FRAME BENCH, WITH SYNTHETIC WOOD SLATS



MODEL #5800D - DOUBLE WASTE RECEPTACLE



MODEL #5242 - TOWEL DISTRIBUTION BIN



MODEL #5875 - TV CABINET



MODEL #5859 - TOWEL RETURN BIN



MODEL #5320BC - BAR CHAIR
MODEL #5320DC - DINING CHAIR
MODEL #5548R - 48" ROUND DINING TABLE

RECYCLED PLASTIC FURNITURE

Easy Installation & Low Maintenance

Little maintenance is required since it is constructed of over 90% high density polyethylene with no wood fillers. It is an ideal, long lasting replacement for traditional wood products, and is more versatile than wood for all of our custom manufactured furniture.

Our recycled plastic is derived from post-consumer polyethylene bottle wastes such as milk containers.

This material is cleaned in a decontamination process to a purity level of over 99% HDPE. It is then compounded into rigid board stock material, the resulting finished product containing over 90% recycled post-consumer waste by weight.

RECYCLED PLASTIC ADVANTAGES

- Natural wood-grain appearance with a slip resistant surface
- Will not splinter, check or rot
- Cuts & shapes like wood
- Superior color retention
- Resistant to insects & termites
- Contains no harmful chemicals



MODEL #4406 - 6 FOOT BENCH

MODEL #4404 - 4 FOOT ARMLESS BENCH



MODEL #4243 - TOWEL RETURN BIN

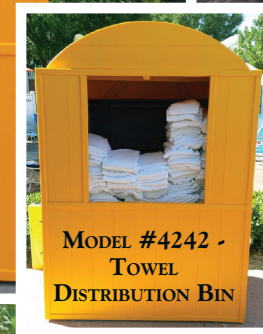

MODEL #4242 - TOWEL DISTRIBUTION BIN



MODEL #4856 - STORAGE BIN



MODEL #4533BT - TABLE

MODEL #4320BC - BAR STOOL



TOWEL RETURN

MODEL #4859 - TOWEL RETURN BIN



MODEL #4533BT - TABLE

MODEL #4321 - BAR STOOL



MODEL #4814 - 48 CAPACITY LIFE JACKET RACK



MODEL #4812 - 24 CAPACITY LIFE JACKET RACK



MODEL #4328 - ADIRONDACK CHAIR



MODEL #4857 - LIFE JACKET BIN



MODEL #4857 - LIFE JACKET BIN

PRODUCT INDEX

MODEL

PRODUCT DESCRIPTION

701	6' Octagon Umbrella (1-1/2" pole)
702	8' Octagon Umbrella (1-1/2" pole)
703.5	10' Octagon Umbrella (1-1/2" steel reinforced pole or 2" pole)
705	12.5' Octagon Umbrella (2" steel reinforced pole or 2-3/8" pole)
706	15' Octagon Umbrella (2" steel reinforced pole or 2-3/8" pole)
707	5' Square Umbrella (1-1/2" pole)
709	7' Square Umbrella with 8 ribs (1-1/2" pole or 2" pole)
710	8' Square Umbrella (1-1/2" steel reinforced pole or 2" pole)
711.5	10' Square Umbrella (1-1/2" steel reinforced pole or 2" pole)
716	6' x 8' Rectangle Umbrella (1-1/2" steel reinforced pole)
718	8' x 10' Rectangle Umbrella (2" steel reinforced pole)
722	15' Decagon Umbrella (2-3/8" steel reinforced pole) (Nautical option available)
726	8' Market Umbrella with 6 ribs (1-1/2" pole)
ST702	8' Synthetic Thatch Umbrella (2" steel reinforced pole)
241	7' x 7' Tent Cabana (1-1/2" aluminum frame)
244	10' x 10' Tent Cabana (1-1/2" aluminum frame)
741	7' x 7' Tent Cabana (1-1/2" steel reinforced wooden frame)
744	10' x 10' Tent Cabana (1-1/2" steel reinforced wooden frame)
750	10' x 12' Portable Awning Umbrella (2" steel reinforced poles)
760	4' x 8' Beach Cabana
201B	6.5' Aluminum Rotating Canopy Market Umbrella (1-1/2" pole)
201P	6.5' Aluminum Rotating Canopy Market Umbrella with pultrusion ribs (1-1/2" pole)
202B	8.5' Aluminum Rotating Canopy Market Umbrella (1-1/2" pole)
202P	8.5' Aluminum Rotating Canopy Market Umbrella with pultrusion ribs (1-1/2" pole)
203SRB	9' Star Aluminum Rotating Canopy Market Umbrella (1-1/2" pole)
203SRP	9' Star Aluminum Rotating Canopy Market Umbrella with pultrusion ribs (1-1/2" pole)
205	8.5' Pagoda-Style Aluminum Umbrella (1-1/2" pole)

OPTIONS

A	Automatic Opening
B	Rotating Canopy
C	Double Vent
D	Steel Reinforced Pole
G1	Wood Tone Finish
G2	Painted Finish
K	Lighting Package
TL	Tilt Mechanism



Y-1	Single Brass Pulley
Y-2	3 to 1 Ratio Brass Pulley System

PRODUCT INDEX

MODEL

PRODUCT DESCRIPTION

218	8' Hexagon Incredible Aluminum Umbrella with aluminum ribs (1-1/2" pole)
218P	8' Hexagon Incredible Aluminum Umbrella with pultrusion ribs (1-1/2" pole)
220	7' Square Incredible Aluminum Rectangle Umbrella with aluminum ribs (1-1/2" pole)
220P	7' Square Incredible Aluminum Rectangle Umbrella with pultrusion ribs (1-1/2" pole)
264	10' Square Aluminum Cantilever Umbrella
601*	1/2" x 21-3/4" Steel Square Base (71 lbs.)
602*	3/8" x 24-1/2" Steel Round Base (57 lbs.)
603*	1/2" x 30" Steel Square Base (138 lbs.)
631*	2-3/4" x 23-3/4" Aluminum Shell; Square Stand (74 lbs.)
633*	2-3/4" x 29-3/4" Aluminum Shell; Round Stand with wheels (96 lbs.)
635*	2-3/4" x 29-3/4" Aluminum Shell; Square Stand with wheels (126 lbs.)
	<i>*Stands available with 1-1/2", 2" or 2-3/8" necks</i>
606*	Threaded Screw-in Stanchion Base
607*	Threaded Screw-in Stanchion Sleeve
606T*	Table Stanchion
607T*	Table Stanchion
608	Crowd Control Stanchion Base
609	Crowd Control Stanchion
611**	Quick-Coupling Base for Item #612 & Item #617
612**	Quick-Coupling Umbrella Stand Insert
613**	Core Plug for Item #611
617	Quick-Coupling Table Pedestal / Umbrella Stand*

UP CHARGES

Awning Grade Fabric
Firesist Fabric
Valance
Teak Wood

***All stanchions available with 611 (1-1/2"), 611A (2") or 611C (2-3/8") neck sizes*